

# PanelStyle

PVC panelling for walls and ceilings





Splashpanel Premium Fino Grey Matt

# PanelStyle

Smart, contemporary designs, 100% waterproof.

Give your home the wow factor with smart PVC panels. Choose from various ranges of fabulous contemporary designs and do it in style with PanelStyle. Our PVC wall and ceiling panelling is an attractive, cost effective alternative to tiles, paint or wallpaper. It is 100% waterproof, quick and easy to fit and comes in a range of thicknesses to suit every budget and application – and with so many designs to choose from, it's the perfect solution for any and every room.

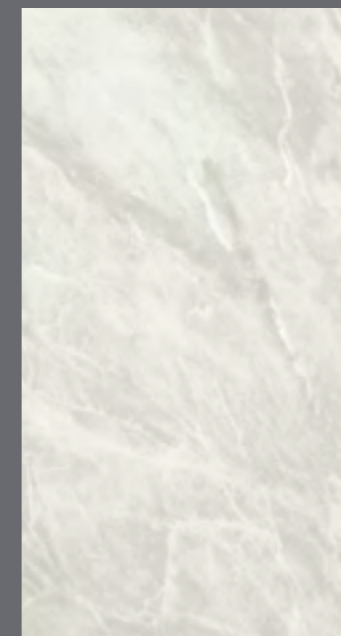

Choose from a huge range of designs



PULL OUT TO VIEW FULL RANGE

# Panelstyle full range overview



Designed for walls, Splashpanel is a stylish and cost effective alternative to tiles. Panels are 100% waterproof – making them perfect for showers, bathrooms and wetrooms. Choose from exclusive Premium designs and a range Narrow panels for those smaller spaces.

## PREMIUM GLOSS 1000mm and 1200mm wide



CALACATTA MARBLE GLOSS SPRE01  
 QUARTZ STONE GLOSS SPRE06  
 FINO GREY GLOSS SPRE07  
 PIETRA GREY GLOSS SPRE03  
 PIETRA ANTHRACITE GLOSS SPRE05

## GLOSS 1000mm and 1200mm wide (continued)



BLACK CRYSTAL GLOSS SPL01

## PREMIUM MATT 1000mm and 1200mm wide

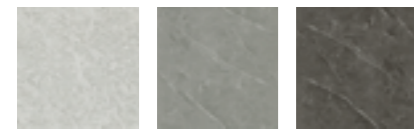

FINO GREY MATT SPRE08  
 PIETRA GREY MATT SPRE02  
 PIETRA ANTHRACITE MATT SPRE04

## MATT 1000mm and 1200mm wide



WHITE MARBLE MATT SPL21  
 WEATHERED STONE MATT SPL19  
 METALLIC CONCRETE MATT SPL16  
 GREY CONCRETE MATT SPL17



## GLOSS 1000mm and 1200mm wide



WHITE GLOSS SPLO8  
 PEARLESCENT WHITE GLOSS SPLO5  
 WHITE CRYSTAL GLOSS SPLO7  
 SILVER TWINE GLOSS SPL13  
 WHITE MARBLE GLOSS SPL20

## NARROW GLOSS 600mm wide



WHITE GLOSS SPN01  
 WHITE SPARKLE GLOSS SPN06  
 WHITE MARBLE GLOSS SPN03  
 GREY MOSAIC GLOSS SPN04  
 LINEA GREY GLOSS SPN05



LIGHT GREY MARBLE GLOSS SPLO3  
 PERGAMON MARBLE GLOSS SPLO4  
 BLUE QUARTZ GLOSS SPL14  
 GREY QUARTZ GLOSS SPL15  
 GREY CONCRETE GLOSS SPL18

## NARROW MATT 600mm wide



WHITE MARBLE MATT SPN02



Fast and easy to fit, Proplas panels are ideal for the walls or ceiling of any room. Pick the patterns and textures that suit your style and create the design you're looking for.

## GLOSS 250mm wide



WHITE HIGH GLOSS PRO1  
 WHITE WOOD EMBEDDED GLOSS PR12  
 WHITE EMBEDDED HIGH GLOSS PRO6  
 WHITE SILVER EMBEDDED HIGH GLOSS PRO4



WHITE SPARKLE HIGH GLOSS PRO3  
 WHITE MARBLE GLOSS PR14  
 PERGAMON MARBLE HIGH GLOSS PRO5  
 SOFT GREY MARBLE HIGH GLOSS PRO7



BLACK SPARKLE HIGH GLOSS PR13

## MATT 250mm wide



WHITE MATT PRO9  
 WHITE ASH MATT PRO2

## TEXTURED 250mm wide



WHITE MOSAIC PR21  
 GREY MOSAIC PR19  
 ANTHRACITE MOSAIC PR20

## MATT 400mm wide



LIGHT SANDSTONE MATT PR18  
 BEIGE CONCRETE MATT PR17  
 GREY MARBLE MATT PR16  
 GREY STONE MATT PR15



The Proplas Tile range offers three tile effect wall products, providing all the great looks of traditional tiling without the mess and maintenance – simply perfect!

## GLOSS 250mm wide

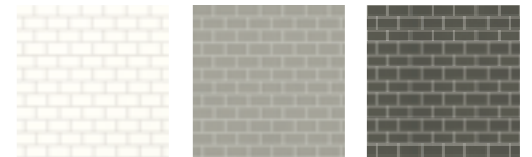

WHITE METRO TILE PRT7  
 LIGHT GREY METRO TILE PRT8  
 DARK GREY METRO TILE PRT9

## MATT 250mm wide



STONE BEIGE PRT2  
 STONE GREY PRT1  
 STONE GRAPHITE PRT3

## MATT 400mm wide







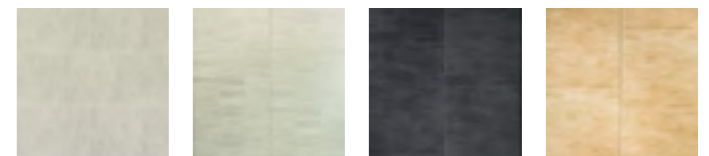



STONE GREY LARGE TILE PRT1  
 STONE GRAPHITE LARGE TILE PRT3

## SATIN 400mm wide



SMOKED GREY LARGE TILE PRTBAL3  
 SMOKED GREY SMALL TILE PRTBAS2  
 ANTHRACITE LARGE TILE PRTBAL1  
 BEIGE LARGE TILE PRTBAL2

# The modern way to create the perfect space

-  100% WATERPROOF
-  COST EFFECTIVE
-  FAST FIT
-  VIRTUALLY MAINTENANCE FREE
-  NON POROUS & MOULD FREE
-  EASY TO CLEAN
-  CAN BE INSTALLED OVER EXISTING TILES
-  5 YEARS DOMESTIC USE WARRANTY
-  FIRE RATED TESTED TO BS EN 13501 - 1:2007



Proplas Tile Stone Graphite (back wall) & Stone Grey (left wall)

## Contents

  
WATERPROOF WALL PANNELLING

6

proplas  
panelling

16

proplas  
tile range

24

Technical  
information &  
accessories

32

# Splashpanel wall panelling.









Durable, hygienic and 100% waterproof

  
**Splashpanel**  
WATERPROOF WALL PANELLING

In addition to standard Splashpanel the collection now also includes the Premium and Narrow ranges. The 10mm thick cellular PVC structure of Splashpanel ensures the panels are durable yet lightweight. The 100% waterproof panels create a fashionable and functional wall covering that's ideal for shower enclosures, bathrooms and wetrooms. Easy to clean, with no grout lines, the Splashpanel hygienic, non-porous surface provides excellent protection against bacteria and stains and is mould resistant too.



Splashpanel Premium Calacatta Marble Gloss

-   
100% WATERPROOF
-   
COST EFFECTIVE
-   
FAST FIT
-   
VIRTUALLY MAINTENANCE FREE
-   
NON POROUS & MOULD FREE
-   
EASY TO CLEAN
-   
CAN BE INSTALLED OVER EXISTING TILES
-   
5 YEARS DOMESTIC USE WARRANTY
-   
FIRE RATED TESTED TO BS EN 13501 - 1:2007

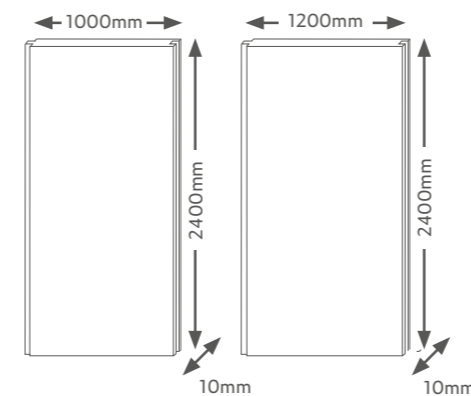

### Splashpanel panel sizes

Coverage per 1000mm panel: 2.4m<sup>2</sup>  
Coverage per 1200mm panel: 2.88m<sup>2</sup>

Please note: 1000mm & 1200mm panels cannot be used together, unless installed with H joint trim.



### PREMIUM DECORS - GLOSS

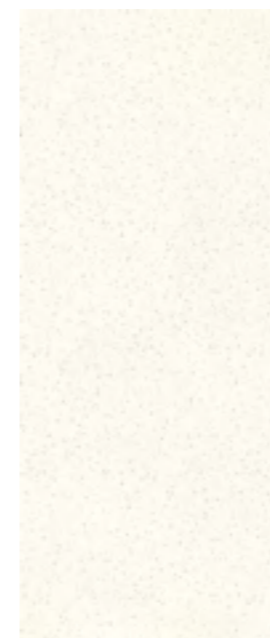

QUARTZ STONE GLOSS  
SPRE06



CALACATTA MARBLE GLOSS  
SPRE01

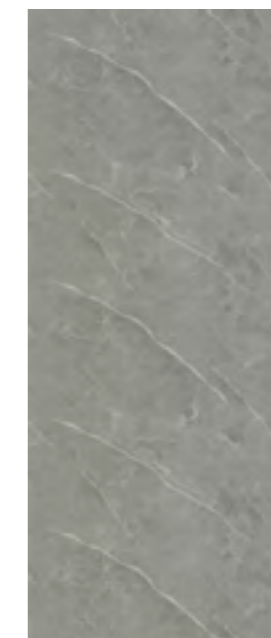

PIETRA GREY GLOSS  
SPRE03

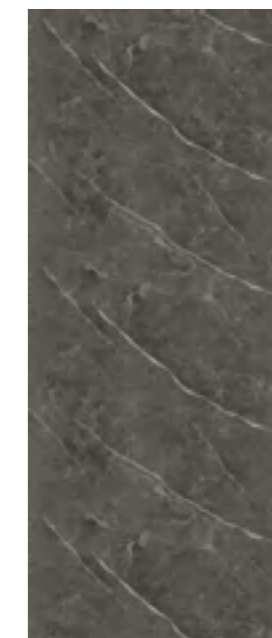

PIETRA ANTHRACITE GLOSS  
SPRE05

### PREMIUM DECORS - MATT

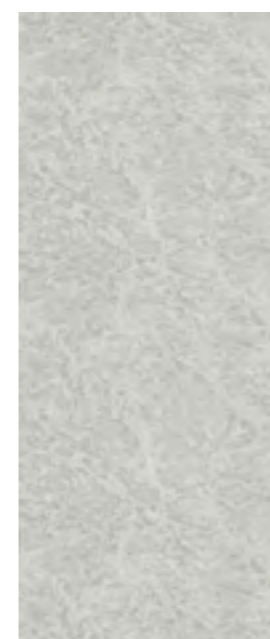

FINO GREY MATT  
SPRE07

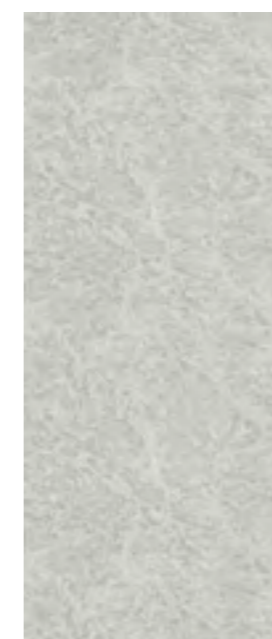

FINO GREY MATT  
SPRE08

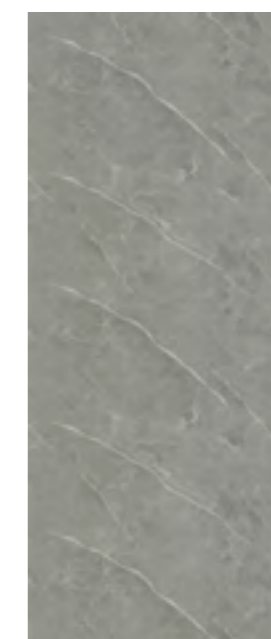

PIETRA GREY MATT  
SPRE02

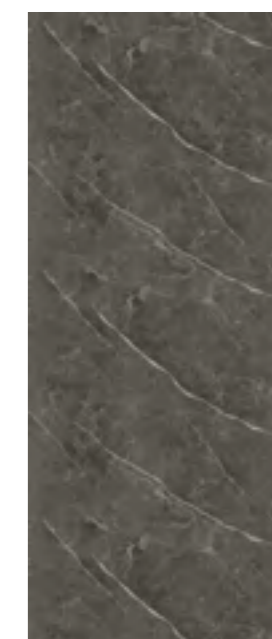

PIETRA ANTHRACITE MATT  
SPRE04



A range of premium panel designs now exclusively available to the Splashpanel collection.

Note: Images opposite are an indication of the product designs and colours and cannot necessarily show, or convey, the look and overall design of the actual product.

Samples can be ordered at [www.panelstyle.co.uk](http://www.panelstyle.co.uk) or by emailing [info@panelstyle.co.uk](mailto:info@panelstyle.co.uk)



Splashpanel Premium Quartz Stone Gloss



Splashpanel offers a large range of gloss and matt decors from sparkling crystals to timeless marble classics.

Note: Images opposite are an indication of the product designs and colours and cannot necessarily show, or convey, the look and overall design of the actual product.

Samples can be ordered at [www.panelstyle.co.uk](http://www.panelstyle.co.uk) or by emailing [info@panelstyle.co.uk](mailto:info@panelstyle.co.uk)



Splashpanel Blue Quartz Gloss

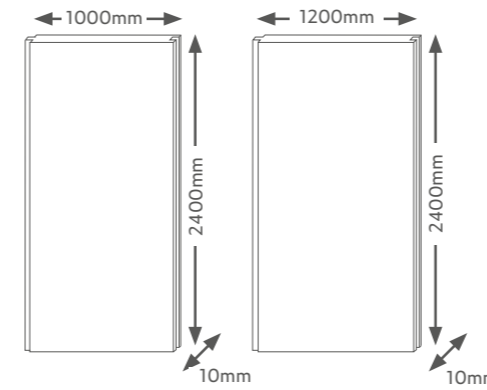

### Splashpanel panel sizes

Coverage per 1000mm panel: 2.4m<sup>2</sup>  
Coverage per 1200mm panel: 2.88m<sup>2</sup>

Please note: 1000mm & 1200mm panels cannot be used together, unless installed with H joint trim.

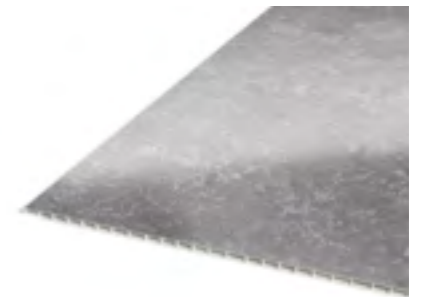

### GLOSS DECORS



WHITE GLOSS  
SPL08



PEARLESCENT WHITE GLOSS  
SPL05

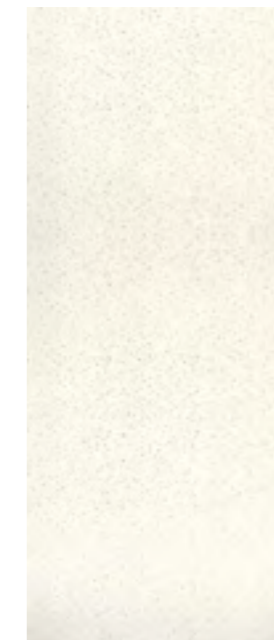

WHITE CRYSTAL GLOSS  
SPL07



SILVER TWINE  
SPL13

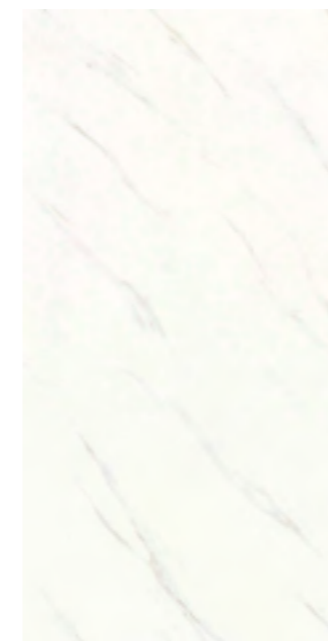

WHITE MARBLE GLOSS  
SPL20

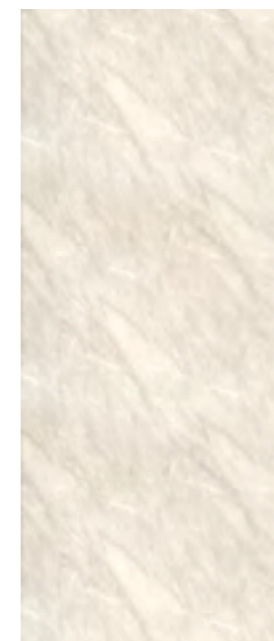

LIGHT GREY MARBLE GLOSS  
SPL03

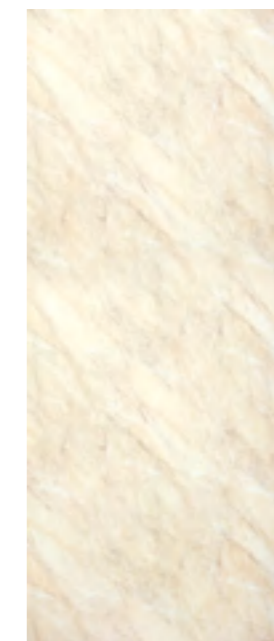

PERGAMON MARBLE GLOSS  
SPL04



BLUE QUARTZ GLOSS  
SPL14

[More gloss decors overleaf >](#)



Splashpanel Grey Quartz Gloss

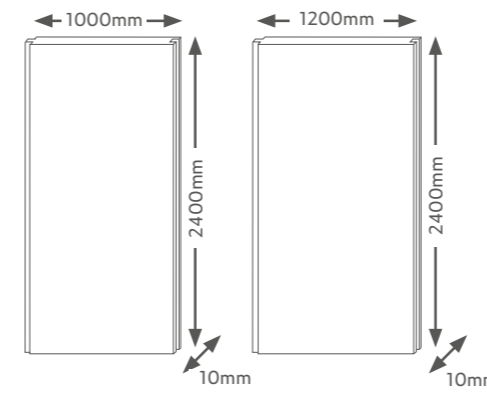

### Splashpanel panel sizes

Coverage per 1000mm panel: 2.4m<sup>2</sup>  
 Coverage per 1200mm panel: 2.88m<sup>2</sup>

Please note: 1000mm & 1200mm panels cannot be used together, unless installed with H joint trim.

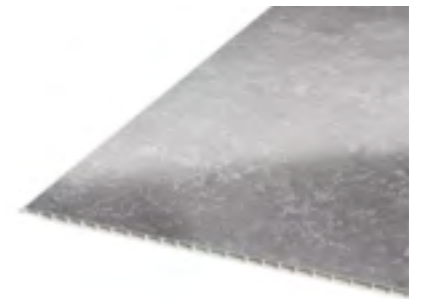

**Splashpanel offers a large range of gloss and matt decors from sparkling crystals to timeless marble classics.**  
 Note: Images opposite are an indication of the product designs and colours and cannot necessarily show, or convey, the look and overall design of the actual product.  
 Samples can be ordered at [www.panelstyle.co.uk](http://www.panelstyle.co.uk) or by emailing [info@panelstyle.co.uk](mailto:info@panelstyle.co.uk)

### GLOSS DECORS



GREY QUARTZ GLOSS  
SPL15

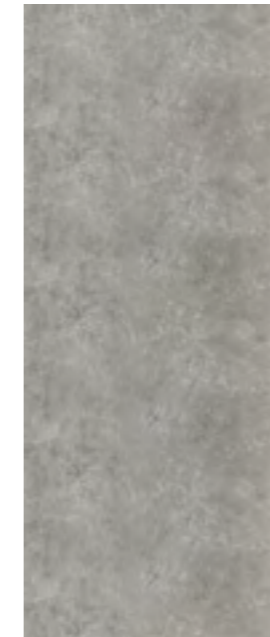

GREY CONCRETE GLOSS  
SPL18



BLACK CRYSTAL GLOSS  
SPL01

### MATT DECORS

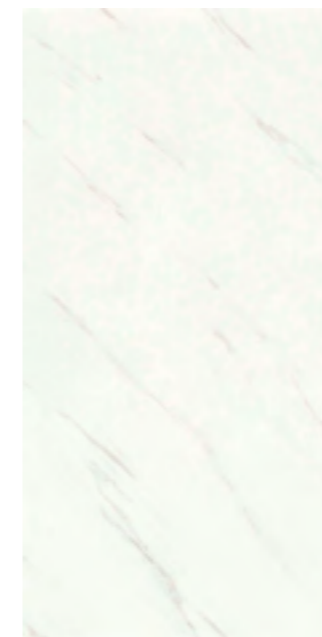

WHITE MARBLE MATT  
SPL21

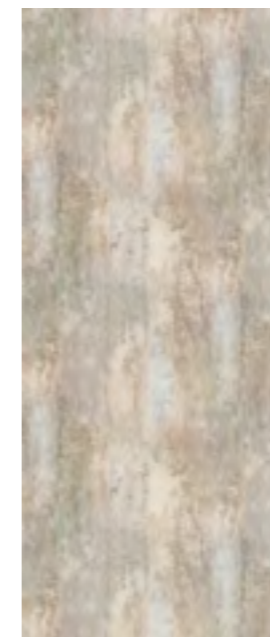

WEATHERED STONE MATT  
SPL19



METALLIC CONCRETE MATT  
SPL16

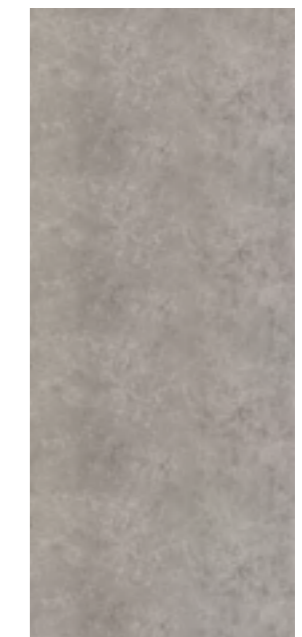

GREY CONCRETE MATT  
SPL17



Splashpanel Metallic Concrete Matt



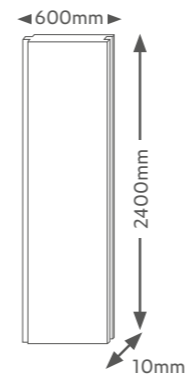
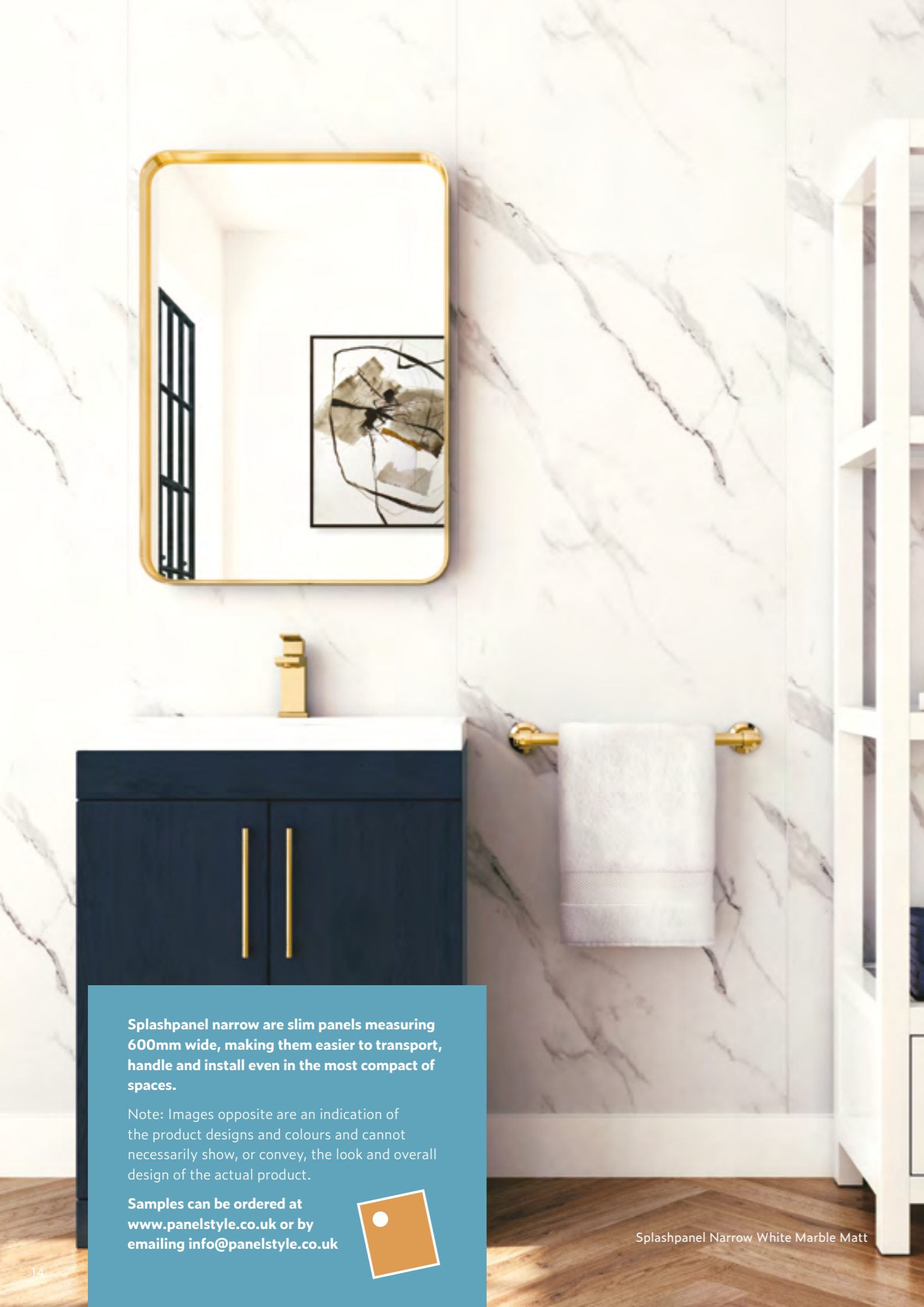

### Splashpanel panel sizes

Panels per pack: 2  
Pack coverage: 2.88m<sup>2</sup>

Please note: due to colour variances, 600mm panels cannot be used with 1000mm and 1200mm panels.



### NARROW DECORS - GLOSS

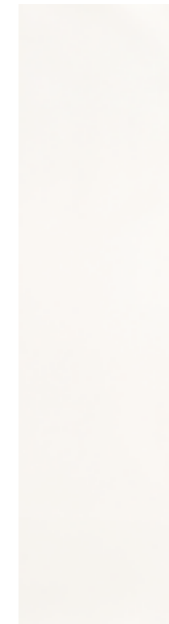

WHITE GLOSS  
SPN01

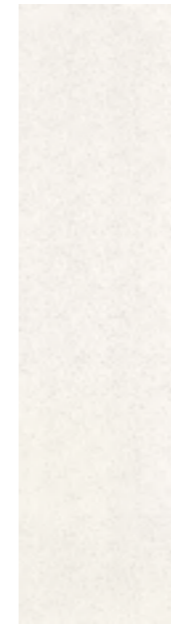

WHITE SPARKLE GLOSS  
SPN06

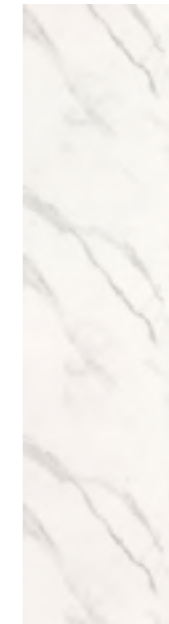

WHITE MARBLE GLOSS  
SPN03

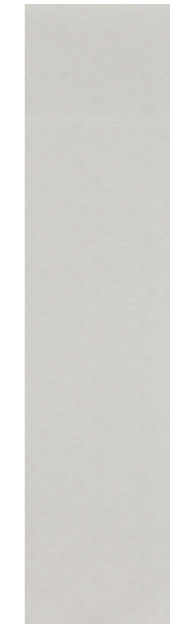

GREY MOSAIC GLOSS  
SPN04



LINEA GREY GLOSS  
SPN05

### NARROW DECORS - MATT



WHITE MARBLE MATT  
SPN02

Splashpanel narrow are slim panels measuring 600mm wide, making them easier to transport, handle and install even in the most compact of spaces.

Note: Images opposite are an indication of the product designs and colours and cannot necessarily show, or convey, the look and overall design of the actual product.

Samples can be ordered at [www.panelstyle.co.uk](http://www.panelstyle.co.uk) or by emailing [info@panelstyle.co.uk](mailto:info@panelstyle.co.uk)



Splashpanel Narrow White Marble Matt









Proplas wall panelling.  
Stylish designs in matt, gloss and textured

proplas  
panelling

With contemporary designs including sparkles and marbles, tactile matt textures in a choice of 250mm or 400mm wide panels, and light reflecting high gloss finishes, Proplas creates a stylish look in any setting including bathrooms, kitchens and utility rooms. Proplas panels are ideal for walls, a selection for ceilings too, and can be simply fixed over existing surfaces like tiles or Artex. Please note that ceiling downlights can be used with Proplas as the product can withstand up to 60 degrees heat; making renovation and refurbishment fast and easy.



Proplas Grey Mosaic

-   
**100%  
WATERPROOF**
-   
**COST  
EFFECTIVE**
-   
**FAST FIT**
-   
**VIRTUALLY  
MAINTENANCE  
FREE**
-   
**NON POROUS  
& MOULD  
FREE**
-   
**EASY TO  
CLEAN**
-   
**CAN BE  
INSTALLED  
OVER EXISTING  
TILES**
-   
**5 YEARS  
DOMESTIC USE  
WARRANTY**
-   
**FIRE RATED  
TESTED TO  
BS EN 13501 -  
1:2007**

Proplas White Embedded High Gloss



A range of 250mm wide gloss and matt decors which are suitable for walls, a selection of which can be used for ceilings.

Images opposite are an indication of the product designs and colours and cannot necessarily show, or convey, the look and overall design of the actual product.

Samples can be ordered at [www.panelstyle.co.uk](http://www.panelstyle.co.uk) or by emailing [info@panelstyle.co.uk](mailto:info@panelstyle.co.uk)

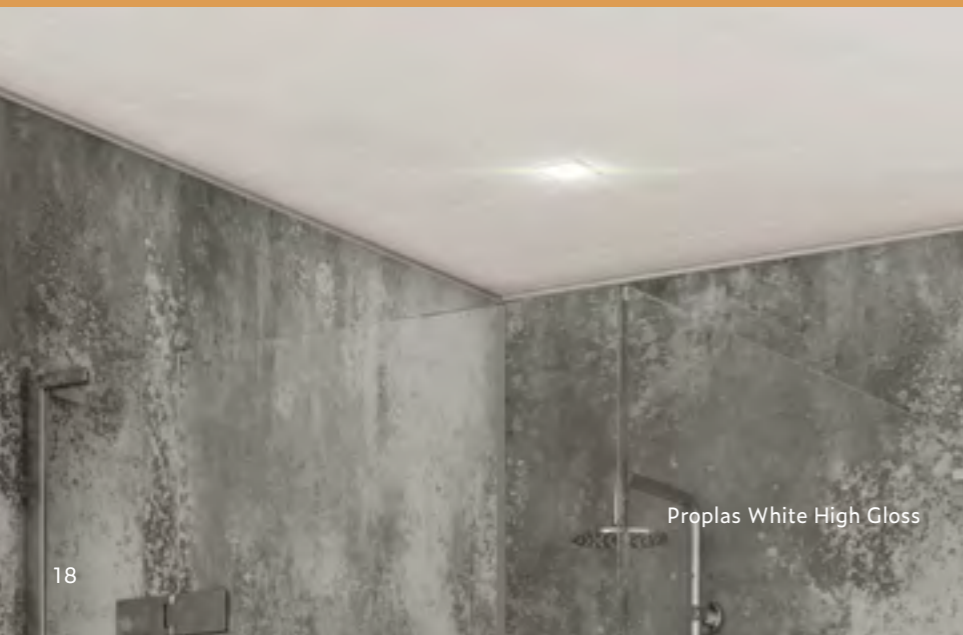

Proplas White High Gloss

proplas  
panelling

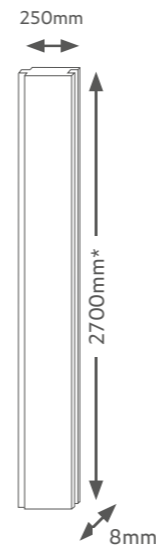

### Proplas panel sizes

\*Available in 4 metre lengths

┌ Ideal for ceilings and walls

Panels per pack: 4

Coverage per 2700mm pack: 2.7m<sup>2</sup>

Coverage per 4000mm pack: 4m<sup>2</sup>

### GLOSS DECORS - 250MM WIDE



WHITE HIGH GLOSS\* PR01

WHITE WOOD EMBEDDED GLOSS\* PR12

WHITE EMBEDDED HIGH GLOSS PR06



WHITE SILVER EMBEDDED HIGH GLOSS PR04

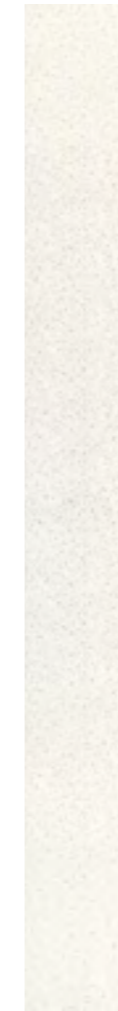

WHITE SPARKLE HIGH GLOSS PR03

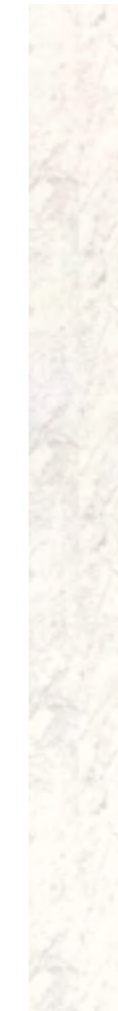

WHITE MARBLE GLOSS PR14



PERGAMON MARBLE HIGH GLOSS PR05



SOFT GREY MARBLE HIGH GLOSS PR07



BLACK SPARKLE HIGH GLOSS PR13

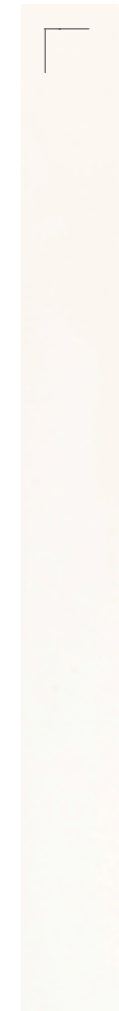

WHITE MATT\* PR09



WHITE ASH MATT PR02

### MATT DECORS - 250MM WIDE

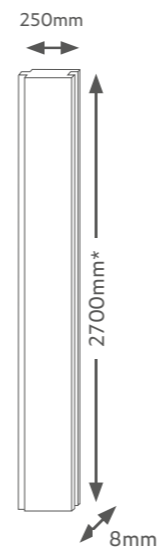

### Proplas panel sizes

Panels per pack: 4  
Coverage per pack: 2.7m<sup>2</sup>

### TEXTURED DECORS - 250MM wide



GREY  
MOSAIC  
PR19

ANTHRACITE  
MOSAIC  
PR20

WHITE  
MOSAIC  
PR21

A range of 250mm wide textured panels in an on-trend mosaic design, which are suitable for walls and ceilings.

Note: Images opposite are an indication of the product designs and colours and cannot necessarily show, or convey, the look and overall design of the actual product.

Samples can be ordered at  
[www.panelstyle.co.uk](http://www.panelstyle.co.uk) or by  
emailing [info@panelstyle.co.uk](mailto:info@panelstyle.co.uk)



Proplas White Mosaic

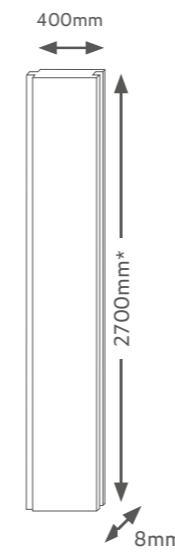

### Proplas panel sizes

Panels per pack: 5  
Coverage per pack: 5.4m<sup>2</sup>

### MATT DECORS - 400MM WIDE



GREY STONE  
MATT  
PR15

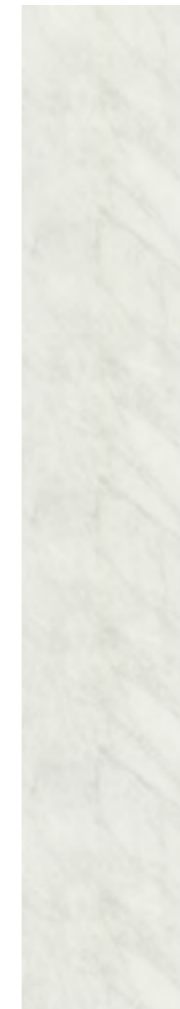

GREY MARBLE  
MATT  
PR16

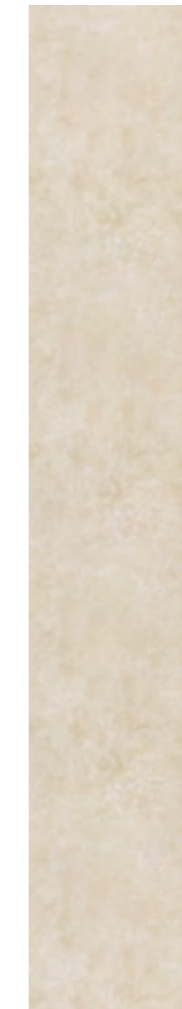

BEIGE  
CONCRETE  
MATT  
PR17

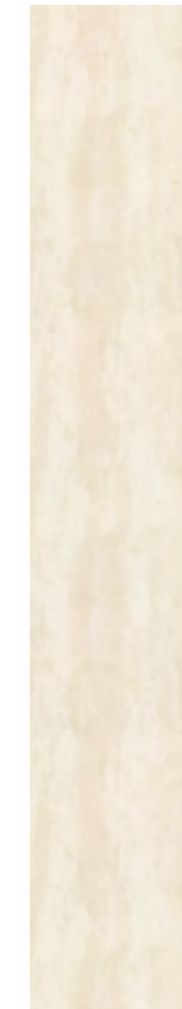

LIGHT  
SANDSTONE  
MATT  
PR18

A range of 400mm wide wall panels in a contemporary matt finish.

Note: Images opposite are an indication of the product designs and colours and cannot necessarily show, or convey, the look and overall design of the actual product.

Samples can be ordered at  
[www.panelstyle.co.uk](http://www.panelstyle.co.uk) or by  
emailing [info@panelstyle.co.uk](mailto:info@panelstyle.co.uk)



Proplas Grey Marble Matt

# Proplas tile wall panelling.

The real look of tiles without the hassle

proplas  
tile range

The Proplas Tile range offers three tile effect wall products with a choice of matt, gloss or satin finish, providing all the great looks of traditional tiling without the mess and maintenance.

The Proplas tile range is a great value, great looking solution that's quick and easy to install. It is 100% waterproof so is ideal in both wet or dry areas. The surface is warmer than tiles and is durable, hygienic and very easy to clean.





Proplas Tile  
Light Grey Metro Tile

- 

100%  
WATERPROOF
- 

COST  
EFFECTIVE
- 

FAST  
FIT
- 

VIRTUALLY  
MAINTENANCE  
FREE
- 

NON POROUS  
& MOULD  
FREE
- 

EASY TO  
CLEAN
- 

CAN BE  
INSTALLED  
OVER EXISTING  
TILES
- 

5 YEARS  
DOMESTIC USE  
WARRANTY
- 

FIRE RATED  
TESTED TO  
BS EN 13501 -  
1:2007

# REALISTIC GROUT LINES

Proplas Tile Stone Graphite (back wall) & Stone Grey (left wall)



The matt panels combine the latest trends for tactile materials, organic colours and natural stones, offering 4 contemporary decors in a choice of widths and tile size, all with a realistic grout line.

Note: Images opposite are an indication of the product designs and colours and cannot necessarily show, or convey, the look and overall design of the actual product.

Samples can be ordered at [www.panelstyle.co.uk](http://www.panelstyle.co.uk) or by emailing [info@panelstyle.co.uk](mailto:info@panelstyle.co.uk)



Proplas Stone Grey Large Tile

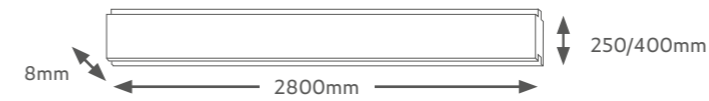

proplas  
tile range

## Proplas matt tile panel sizes

- Panels per 250mm pack: 4
- Panels per 400mm pack: 5
- Coverage per 250mm pack: 2.8m<sup>2</sup>
- Coverage per 400mm pack: 5.6m<sup>2</sup>

Due to the staggered effect of the installed product, the average usable panel coverage is between 2.4m<sup>2</sup> and 2.6m<sup>2</sup> for 250mm panels, and between 4.8m<sup>2</sup> and 5.2m<sup>2</sup> for 400mm panels.



## MATT TILE 250MM WIDE



STONE BEIGE  
PRT2



STONE GREY  
PRT1

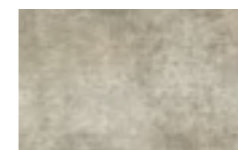

STONE GRAPHITE  
PRT3



## PROPLAS MATT TILE 400MM WIDE

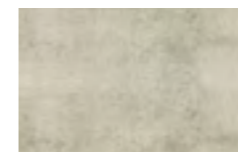

STONE GREY  
LARGE TILE  
PRT1

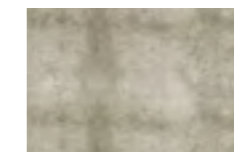

STONE GRAPHITE  
LARGE TILE  
PRT3

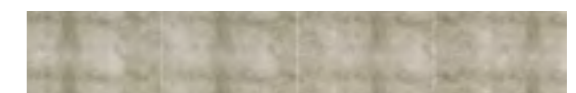

## Proplas gloss tile panel sizes

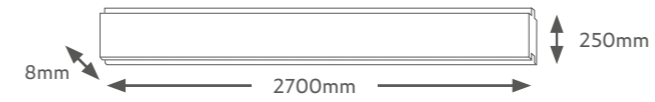

Panels per pack: 4  
Pack coverage: 2.7m<sup>2</sup>

Due to the staggered effect of the installed product, the average usable panel coverage is between 2.4m<sup>2</sup> and 2.6m<sup>2</sup>

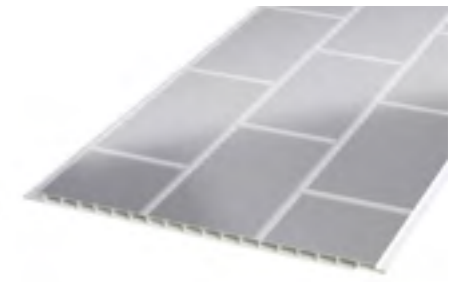

## METRO TILE 250MM WIDE



WHITE METRO TILE  
PRT7



LIGHT GREY METRO TILE  
PRT8

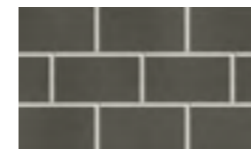

DARK GREY METRO TILE  
PRT9



Metro Tile is an on trend design aimed to mimic the look and feel of tiles without the time consuming installation and arduous upkeep of individual tiles, making this a perfect choice for your kitchen or bathroom.

Note: Images opposite are an indication of the product designs and colours and cannot necessarily show, or convey, the look and overall design of the actual product.

Samples can be ordered at  
[www.panelstyle.co.uk](http://www.panelstyle.co.uk) or by  
emailing [info@panelstyle.co.uk](mailto:info@panelstyle.co.uk)



Proplas White Metro Tile



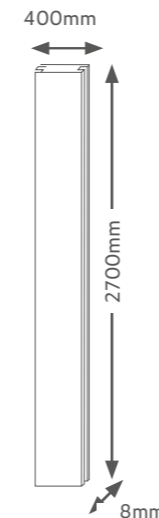

Proplas  
satin tile  
panel sizes

Panels per pack: 5  
Pack coverage: 5.4m<sup>2</sup>

SATIN TILE 400MM WIDE



ANTHRACITE  
LARGE TILE  
PRTBAL1



SMOKED GREY  
SMALL TILE  
PRTBAS2



BEIGE  
LARGE TILE  
PRTBAL2



SMOKED GREY  
LARGE TILE  
PRTBAL3

The satin panels feature both a small and large format tile design, available in on trend grey and rich neutral tones. Each panel has a smooth satin finish with a bevelled edge to mirror the appearance of real tiles.

Note: Images opposite are an indication of the product designs and colours and cannot necessarily show, or convey, the look and overall design of the actual product.

Samples can be ordered at  
[www.panelstyle.co.uk](http://www.panelstyle.co.uk) or by  
emailing [info@panelstyle.co.uk](mailto:info@panelstyle.co.uk)



Proplas Smoked Grey Small Tile

# TECHNICAL INFORMATION

## FIXING OPTIONS

PanelStyle PVC waterproof panelling is fixed by adhering the panels to an appropriately sound, flat and plumb subsurface. If the subsurface is uneven then a timber batten frame should be installed to create a suitable subsurface to adhere to. Full installation instructions are supplied with all products and are also available to download from [www.panelstyle.co.uk](http://www.panelstyle.co.uk)

## CARE & MAINTENANCE

All PanelStyle PVC waterproof panelling is more hygienic and easier to maintain than tiles. The non-porous surface provides excellent protection against bacteria and stains. PanelStyle anti-bacterial cleaner kills germs and keeps hard surfaces clean without scratching. **Please note:** abrasive cleaners and bleaches **MUST NOT** be used on any PanelStyle product. Do not cut or store panels in direct sunlight, as can create an adverse reaction to the panels decorative layers.

## 5 YEAR WARRANTY

PanelStyle PVC waterproof panels carry a 5 year residential/domestic warranty against manufacturing defects. A full copy of the warranty is available to download from [www.panelstyle.co.uk](http://www.panelstyle.co.uk). Note installation of the product must be in accordance with the fitting instructions supplied as incorrect installation will void the warranty.



## FIRE RATED

Fire Rating tested to BS EN 13501-1:2007 achieving and F.R. classification of C,S3,D0.



This PVC product can be recycled at your local recycling facility



ETHICALLY SOURCED 

Whilst every care has been taken to ensure that the information included in this document was accurate at the time of printing, we reserve the right to change product specifications at any time without prior notice.

The photographs reproduced in this publication are within the constraints of the printing process and are not to be used for matching purposes. All photographs are used for approximate representation only and may not show the actual products on offer. E&OE.

	Colour	Length	Splashpanel Accessory Code	Proplas inc. Tile Accessory Code
	Silver	2400mm	SPEN1	-
	Silver	2700mm	-	PREN1
	Silver	4000mm	-	BXEN1
	White	2400mm	SPEN3	-
	White	2700mm	-	PREN3
	White	4000mm	-	BXEN3
	Black	2400mm	SPEN2	-
	Black	2700mm	-	PREN2

	Colour	Length	Splashpanel Accessory Code	Proplas inc. Tile Accessory Code
	Silver	2400mm	SPIC1	-
	Silver	2700mm	-	PRIC1
	Silver	4000mm	-	BXIC1
	White	2400mm	SPIC3	-
	White	2700mm	-	PRIC3
	White	4000mm	-	BXIC3
	Black	2400mm	SPIC2	-
	Black	2700mm	-	PRIC2

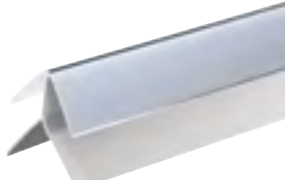
	Colour	Length	Splashpanel Accessory Code	Proplas inc. Tile Accessory Code
	Silver	2400mm	SPEC1	-
	Silver	2700mm	-	PREC1
	White	2400mm	SPEC3	-
	White	2700mm	-	PREC3
	Black	2400mm	SPEC2	-
	Black	2700mm	-	PREC2

	Colour	Length	Splashpanel Accessory Code	Proplas inc. Tile Accessory Code
	Silver	2400mm	SPHJ1	-
	Silver	2700mm	-	PRHJ1
	White	2400mm	SPHJ3	-
	White	2700mm	-	PRHJ3
	Black	2400mm	SPHJ2	-
	Black	2700mm	-	PRHJ2

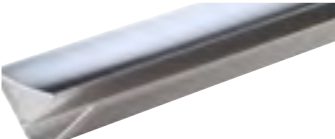
	Colour	Length	Splashpanel Accessory Code	Proplas inc. Tile Accessory Code
	Silver	2700mm	-	PRCM1
	White	2700mm	-	PRCM3
	Black	2700mm	-	PRCM2

Cleaner	Code	Description
	SPACCLE750ML00000	PanelStyle Superclean 750ml

The cost effective alternative to tiles,  
paint or wallpaper



Splashpanel Grey Concrete Matt



100%  
WATERPROOF



COST  
EFFECTIVE



FAST FIT



VIRTUALLY  
MAINTENANCE  
FREE



NON POROUS  
& MOULD  
FREE



EASY TO  
CLEAN



CAN BE  
INSTALLED  
OVER EXISTING  
TILES



5 YEARS  
DOMESTIC USE  
WARRANTY



FIRE RATED  
TESTED TO  
BS EN 13501 -  
1:2007

# PanelStyle



Proplas White Ash Matt

PVC panelling for walls and ceilings

[info@panelstyle.co.uk](mailto:info@panelstyle.co.uk) | [www.panelstyle.co.uk](http://www.panelstyle.co.uk) | 0845 023 0374

Samples can be ordered at [www.panelstyle.co.uk](http://www.panelstyle.co.uk) or by emailing [info@panelstyle.co.uk](mailto:info@panelstyle.co.uk)